



### Main applications

- *Plastics extrusion lines and injection moulding machines*
- *Polymerization plant for synthetic fibre production*
- *Rubber moulding machinery*
- *Driers for ceramics and components for the building industries*
- *Chemical and pharmaceutical industries*
- *Industrial electric ovens*
- *Food processing plants*

### Main features

- *Command input from analogue voltage or current signal or potentiometer.*
- *Switching at voltage zero crossing.*
- *Partialization of wave train power with dynamically optimized time cycle.*
- *Antiparallel double SCR*
- *2 led for supply indication, "ON" state, 1 optional LED for load interrupt alarm*
- *4000V isolation between input circuit and power output*
- *MOV (varistor)*
- *Optional monitoring of interrupted load*
- *DIN rail mounting (standard); Panel mounting (optional)*

### PROFILE

The GTF family of solid-state relays has been designed with the aim of providing very accurate control of the load thanks to an analog control input, in voltage at 0...5V; 0...10V or in current at 0...20/4...20mA or a potentiometer (from 1K $\Omega$  to 10 K $\Omega$ ).

The electronic design ensures that the cycle time for proportioning the power is automatically optimized.

The number of cycles that the GTF supplies to the load (wave trains) for a given input signal is calculated to be the minimum possible to maintain the necessary accuracy.

This guarantees a very fast and accurate control loop that enables the GTF, driven by a controller or a PLC with analogue output, to obtain very precise control.

The GTF can be used in three phase systems, using master-slave control architecture in which the control signal drives only one GTF (master) and this unit supplies the synchronized signals to the other GTF slaves.

Two GTS modules can also be used as slaves.

A load interrupt control option (HB) is available without having to use an external current transformer; alarm limit is settable with trimmer and yellow LED signal, with voltage-free contact, normally open.

The GTF solid-state relay has a green LED to indicate the presence of the 24Vac power supply and a red LED to indicate the switching based on the analog control input signal.

The LED signal will be continuous (off at minimum, on at maximum) at the ends of the scale, pulsing for intermediate values.

The units offer optional accessories for panel mounting, fuses and fuseholders, current transformer, isolation transformers

### TECHNICAL DATA

#### General features

Category of use AC1  
 Nominal voltage - 480Vac (max. range 24...530Vac)  
 Nominal frequency: 50/60Hz  
 Non-repetitive voltage: 1200Vp  
 Zero switching voltage:  $\leq 20V$   
 Voltage drop at nominal current  $\leq 1,4V_{rms}$   
 Power factor = 1

#### Control inputs

Voltage: 0...5Vdc, 0...10Vdc (impedance  $\geq 100K\Omega$ )  
 Current: 0...20mA, 4...20mA (impedance 125 $\Omega$ )  
 Potentiometer: from 1K to 10K $\Omega$  (auto-fed by GTF)

#### OUTPUTS

#### GTF 25 (SCR version)

Nominal current:  
 25A@40°C in continuous service  
 Non-repetitive overcurrent  $t=20ms$ : 400A  
 $I^2t$  for blowout  $\leq 645A^2s$   
 dV/dt critical with output deactivated:  
 1000V/ $\mu s$

### **GTT 40 (SCR version)**

Nominal current:

40A@40°C in continuous service

Non-repetitive overcurrent t=20 ms:

600A

I<sup>2</sup>t for blowout: ≤ 1010A<sup>2</sup>s

dV/dt critical with output deactivated:

1000V/μs

### **GTT 50 (SCR version)**

Nominal current:

50A@40°C in continuous service

Non-repetitive overcurrent t=20 ms:

1150A

I<sup>2</sup>t for blowout: ≤ 6600A<sup>2</sup>s

dV/dt critical with output deactivated:

1000V/μs

### **GTT 60 (SCR version)**

Nominal current:

60A@40°C in continuous service

Non-repetitive overcurrent t=20 ms:

1150A

I<sup>2</sup>t for blowout: ≤ 6600A<sup>2</sup>s

dV/dt critical with output deactivated:

1000V/μs

### **GTT 75 (SCR version)**

Nominal current:

75A@40°C in continuous service

Non-repetitive overcurrent t=20 ms:

1300A

I<sup>2</sup>t for blowout: ≤ 8000A<sup>2</sup>s

dV/dt critical with output deactivated:

1000V/μs

### **GTT 90 (SCR version)**

Nominal current:

90A@40°C in continuous service

Non-repetitive overcurrent t=20 ms:

1500A

I<sup>2</sup>t for blowout: ≤ 11200A<sup>2</sup>s

dV/dt critical with output deactivated:

1000V/μs

### **GTT 120 (versione SCR)**

Nominal current:

120A@40°C in continuous service

(complete with fan and standard thermostat).

Non-repetitive overcurrent t=20 ms:

1500A

I<sup>2</sup>t for blowout: ≤ 11200A<sup>2</sup>s

dV/dt critical with output deactivated:

1000V/μs

### **Isolation**

Rated isolation voltage input/output:

4000Vac

### **Ambient conditions**

#### **• Working temperature:**

0 to 80°C (see the dissipation curves)

#### **• Max. relative humidity:**

50%...40°C

#### **• Max. installation altitude:**

2000m asl

#### **• Pollution level: 3**

#### **• Storage temperature:**

-20...+85°C

### **Power supply:**

24Vac ±10%, 50/60 Hz

Absorption: 1.5VA

Max. isolation voltage: 300Vdc

### **Options:**

Interrupted HB load alarm.

Controls the load by measuring current on a shunt inside the device. The alarm limit is set with a multirev monorev trimmer.

The alarm output is obtained by means of a solid state relay. The contact is normally open (max. 30V, 150mA, conduction resistance 15 Ohm).

### **Installation notes**

Use the high-speed fuse specified in the catalog according to the connection example given.

- Applications with solid state power units must also include an automatic safety switch to cut out the load power line.

In order to obtain best reliability, it is important to install a heatsink correctly inside the panel, to reach an adequate thermal exchange between the device and the surrounding air in natural convection conditions.

Mount it vertically (max. 10° inclination from the vertical axis)

• Vertical distance between a device and the panel walls >100mm

• Horizontal distance between a device and the panel walls: at least 20mm

• Vertical distance between devices: at least 300mm.

• Horizontal distance between devices: at least 20 mm. Make sure that the wire raceways do not reduce such distances: if they do, install the groups cantilevered to the panel so that air can flow vertically over the heat sink without obstructions.

### **Attention:**

if you replace a GTT from an earlier series, note the following:

- the GTT cannot be used as a slave of a MASTER GTT from a previous series;

- the GTT can drive a slave from a previous series only if a 10kW resistance is connected in series to the master/slave connection

- see the connection examples.

### **Limits of use**

• Dissipation of thermic power on the device with restraints on the ambient temperature of the installation.

• Equip the cabinet with an external air change or air-condition it, to put out dissipated power.

• Installation restraints (distances to be respected to grant dissipation with natural convection).

• Line transistor max. voltage and derivative limits, for which the solid state relay is equipped with inside safety devices (based on the models).

• Leakage current < 3mA for SCR version GTTs.

(max. value with rated voltage and junction temperature of 125°C)

**“Zero crossing” with variable cycle time**

Examples of the operation of the GTT for different values of the input drive signal and the consequent different cycle times (100msec and 40msec respectively)

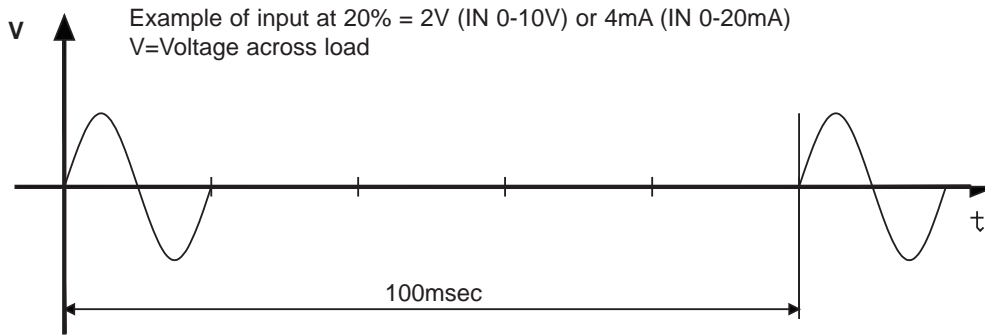

**Logic output control for GTT**

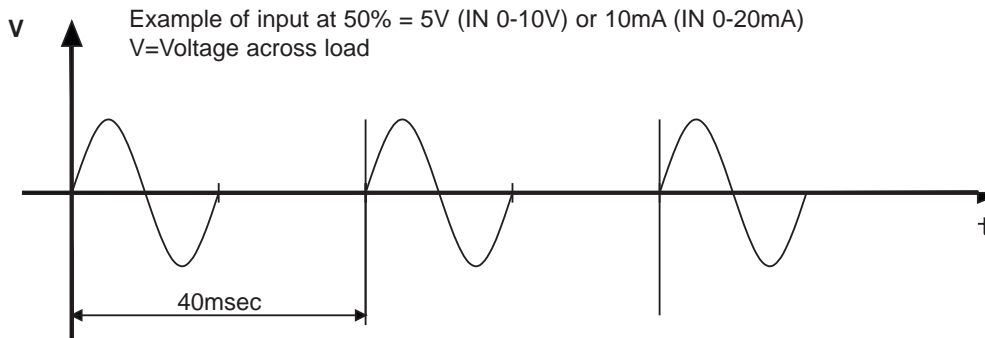

**GTT thermal protection**

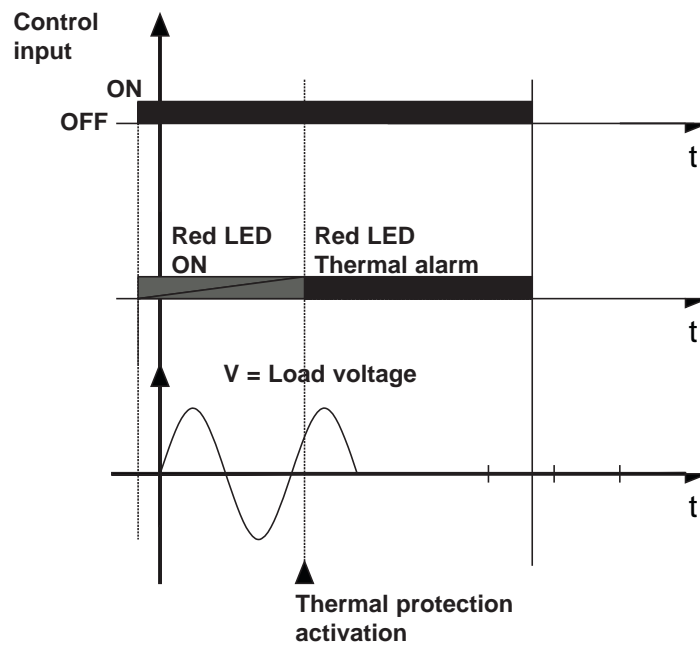

## FACEPLATE DESCRIPTION

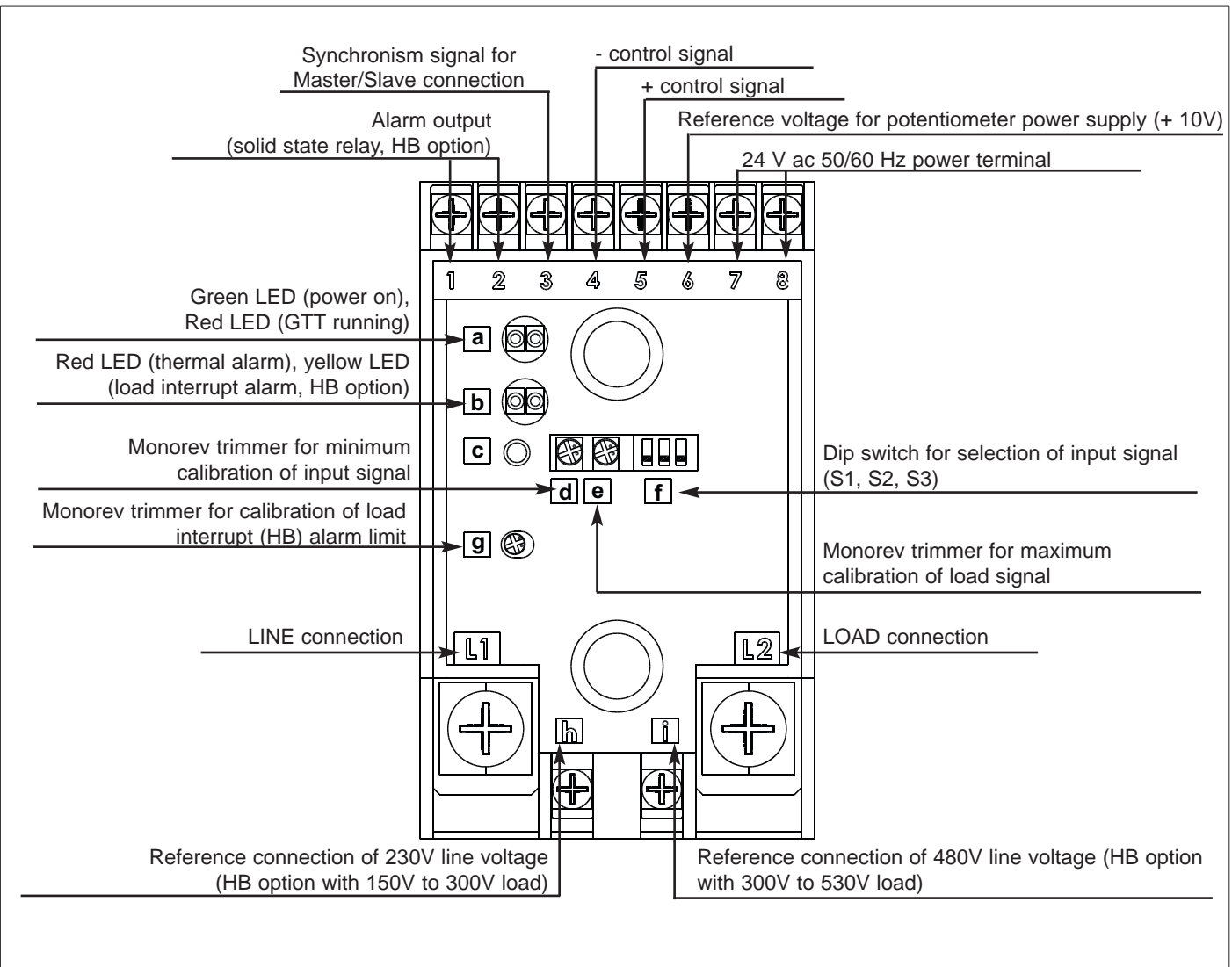

## CALIBRATION PROCEDURE OF THE INPUT SIGNAL

The solid-state power unit, GTT, is supplied factory calibrated for 0..5V, 0..10V, 0..20mA, 4..20mA inputs, 10Kohm potentiometer. Minimum and maximum values are adjusted with two monorev trimmers (d,e). Input signal type is selected with the f adjustment dip switches (S1,S2,S3).

Control signal	Dip Switch Position			e	V/mA In --- T	f	Rin
	S1	S2	S3				
0...5Vdc	OFF	OFF	ON		On: Off:	100KΩ	
0...10Vdc	ON	OFF	ON		0-10V: 0-20mA:	100KΩ	
0...20mA	OFF	ON	ON		4-20mA:	125Ω	
4...20mA	OFF	ON	OFF		4-20mA:	125Ω	

Minimum adjustment trimmer (d) turned fully counterclockwise sets the start conducting limit at 4% of the signal; turned fully clockwise, the minimum conducting limit is set at 18% of the input signal.

Maximum adjustment trimmer (e) turned fully clockwise sets the full conducting limit at 96% of the signal; turned fully counterclockwise, the full conducting limit is set at 82% of the input signal

## INTERRUPTED LOAD ALARM

The interrupted load alarm function enables the GTT to diagnose a variation of the load current (compared to a set limit), distinguishing it from one caused by a change in grid voltage. e. The solid state power unit must therefore be supplied with the voltage applied to the load terminals, i.e.: LOAD (L2): already connected internally;  
LINE (**h** or **i**): connect terminal **h** for voltages from 150 to 300V; connect terminal **i** for voltages from 300 to 530V.  
The alarm activates (relay closed and yellow alarm LED on) when the current, during the conduction of the device, falls below a preset level that may be adjusted using the trimmer on the faceplate.

Calibration procedure (refer to the faceplate description drawing)

- 1) Use the adjustment system (or a calibrator) in order to supply the maximum signal (100% conduction or the "ON" LED always illuminated). As an alternative, you can configure the GTT to 0-10 V DC input configuration and connect terminals 5 and 6.
- 2) Use a current sensing pliers to check that the load current is at rated level.
- 3) Turn alarm limit adjustment trimmer (g) fully clockwise. Check that yellow alarm LED (b) turns on.
- 4) Slowly turn trimmer (g) counterclockwise until the alarm LED turns off.
- 5) Turn the trimmer counterclockwise another 1/10 of a turn (1 notch on the scale).  
In this way, the alarm limit is set below 10% of the rated load current.

N.B:

the partial load break alarm function operates with power partialization exceeding 15%. For partializations below 20%, tripping times increase due to the reduced load activation time. For correct operation of the option, the load current has to exceed 30% of rated current for the GTT.

## Notes on use of the GTT with the digital On/Off control

- The logic control signal has to be connected with the correct polarities to terminals 4 and 5 of the analog input.
- Turn minimum adjustment trimmer (d) fully counterclockwise and maximum adjustment trimmer (e) fully clockwise.
- Set the 3 dip switches (f) to off.

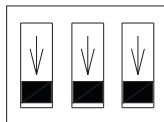

For applications with a very short work cycle, you can drive the solid state group by means of the Master/Slave signal by driving it with a digital signal (OFF = 0 V dc; ON = from 4 V dc to 10 V dc)

## Inhibiting the GTT

You can inhibit operation of the GTT by means of the Master/Slave signal.  
To inhibit, connect control signal - (4) with the synchronism signal for Master/Slave connection (3).

## Notes on use of the GTT in Master/Slave configuration

The GTT can be used as a master to drive other solid state groups (slaves). With Master/Slave signal (3), you can drive up to 9 GTTs (see connection examples for GTT solid state power relays with three-phase load). You can also use a GTT to drive GTS solid state power relays (maximum of 2), as shown in the connection diagrams for GTT/GTS solid state power relays with three-phase load (attention: the HB option cannot be used for a three-phase application with neutral).

## DISSIPATION CURVES

Rated current curves based on room temperature.

**GTT 25 / 40**

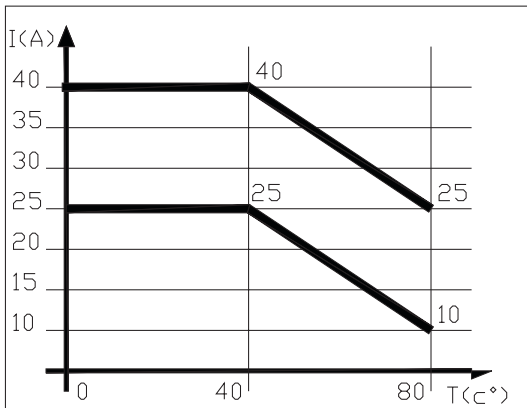

**GTT 50 / 60**

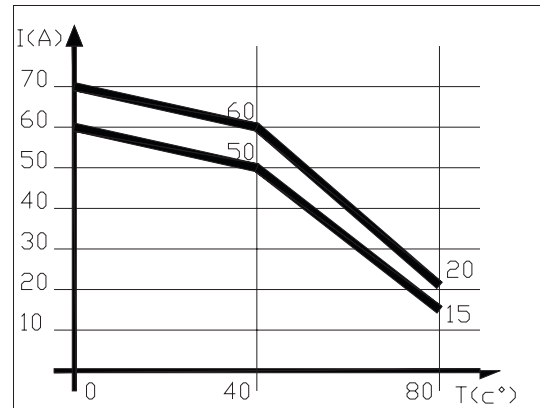

**GTT 75 / 90 / 120**

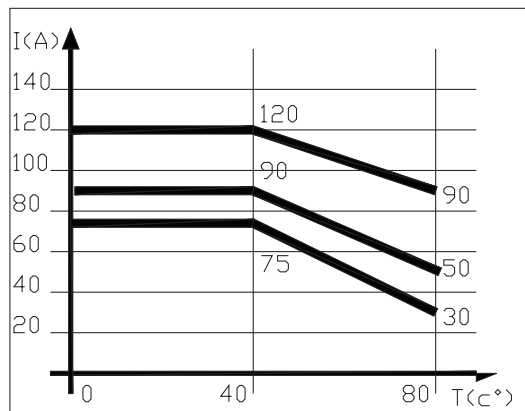

The GTT 120 curves refer to the device complete with standard fan running.

## TABLE FOR TERMINAL CHOICE OF POWER TERMINAL BOARD

Size	CONTROL TERMINAL			POWER TERMINAL			GROUND TERMINAL •	
	Contact area (WxD) screw type	Pre-isolated wire terminal	Max. section ** conductor tightening torque	Contact area (WxD) screw type	Pre-isolated wire terminal	Max. section ** wire tightening torque	Contact area (WxD) screw type	Max. section ** conductor tightening torque
25/40A	6,3x9	Eye/fork/ tip	2,5mm <sup>2</sup> 0,6Nm Max	16x18	Eye/fork	50mm <sup>2</sup> 3,5-6 Nm	14x16	50mm <sup>2</sup> 1,8-2,5Nm
50/60A	M3			M6			M5	
75-90A	6,3x9	Eye/fork/ tip	2,5mm <sup>2</sup> 0,6Nm Max	16x18	Eye/fork	50mm <sup>2</sup> 3,5-6 Nm	14x16	50mm <sup>2</sup> 1,8-2,5 Nm
	M3			M6			M5	
120A	6,3x9	Eye/fork/ tip	2,5mm <sup>2</sup> 0,6Nm Max	16x18	Eye/fork	50mm <sup>2</sup> 3,5-6 Nm	14x16	50mm <sup>2</sup> 1,8-2,5 Nm
	M3			M6			M5	

(\*\*)The maximum sections indicated refer to unipolar copper wires with PVC insulation.

- Note: you have to use an eye terminal for the ground connection.  
(WxD) = width x depth

## DIMENSIONS AND CUT-OUT

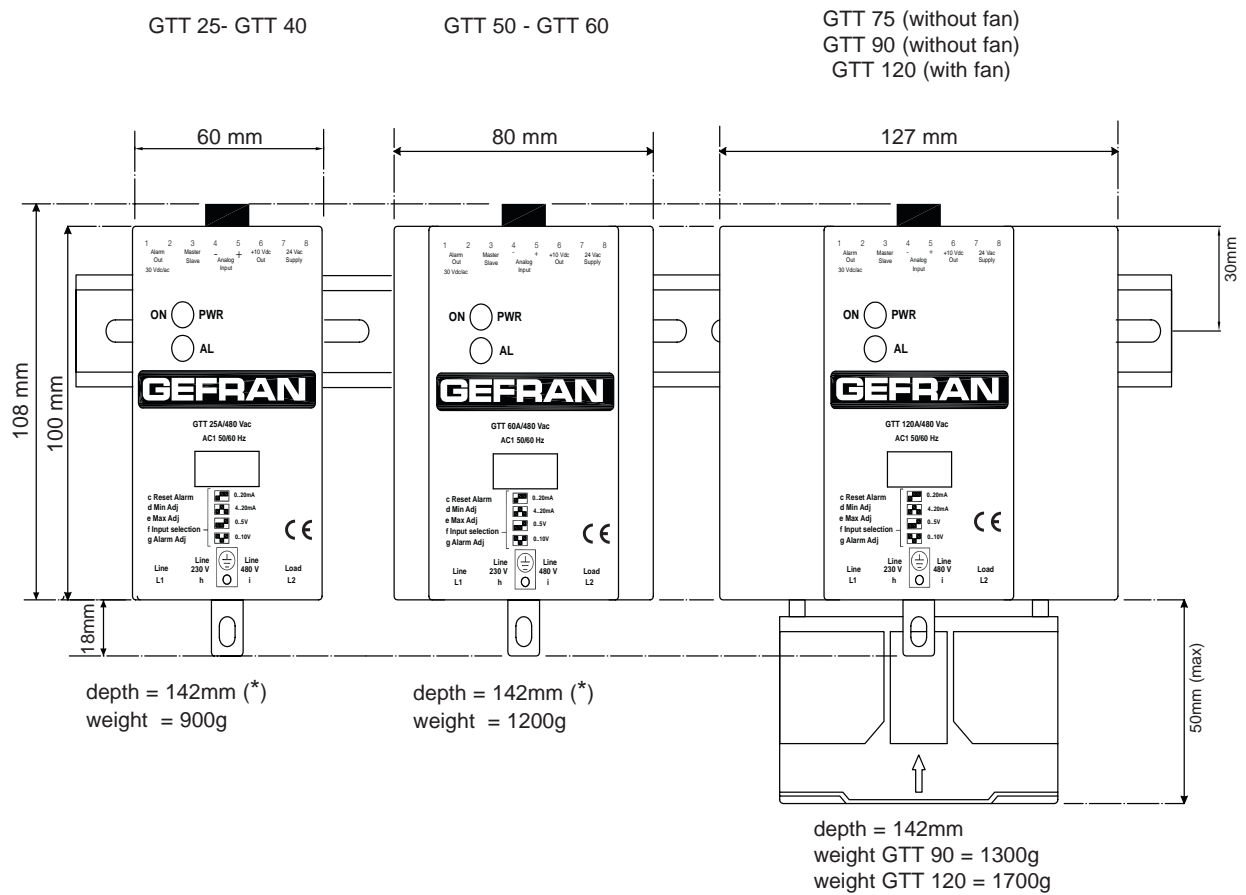

## TEMPLATE DIMENSIONS

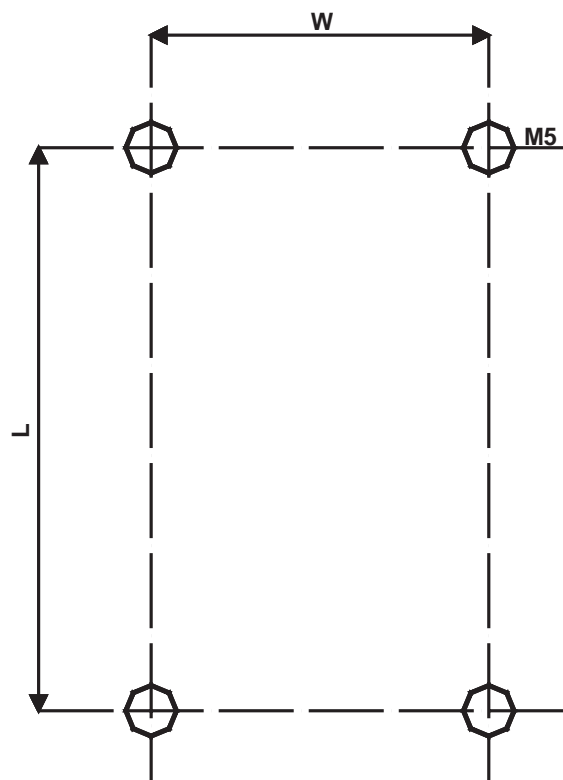

	L (mm)	W (mm)
GTT 25 - 40 - 50 - 60	112	44
GTT 75 - 90 - 120	112	113

## CONNECTION EXAMPLES

Single-phase connection with optional monitoring of interrupted load (command input from analog signal or potentiometer)

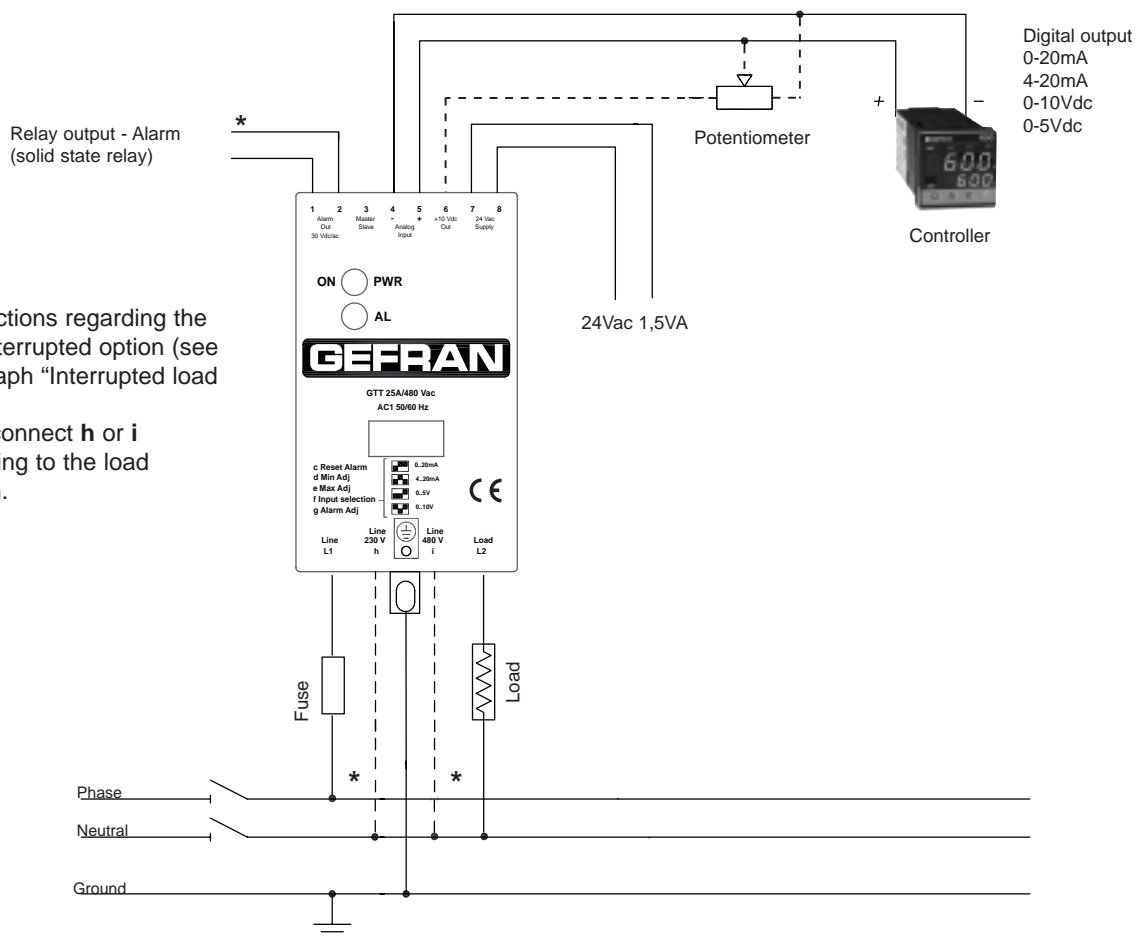

Star or delta three-phase connection without neutral, with control of two phases.

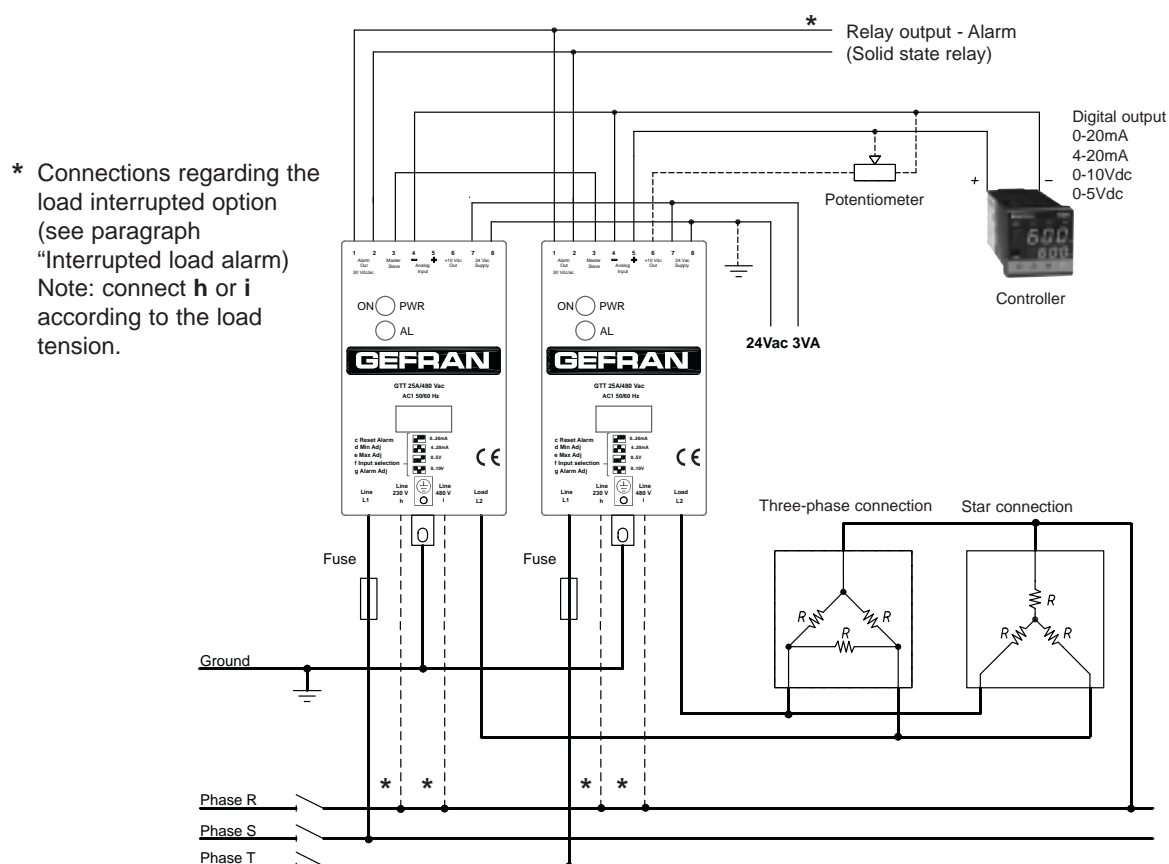



# CONNECTION EXAMPLES

Three-phase star connection with neutral.

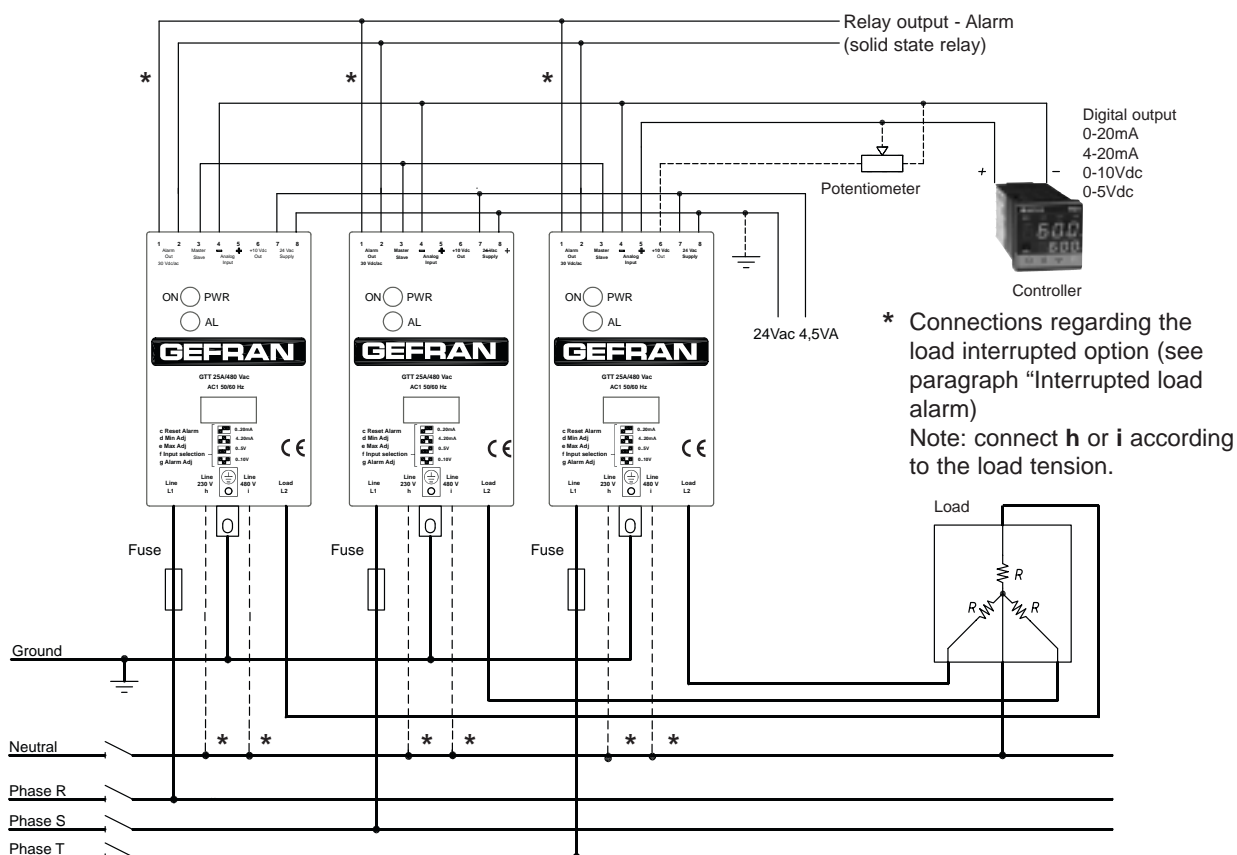

Star or delta three-phase connection without neutral, with control of three phases.

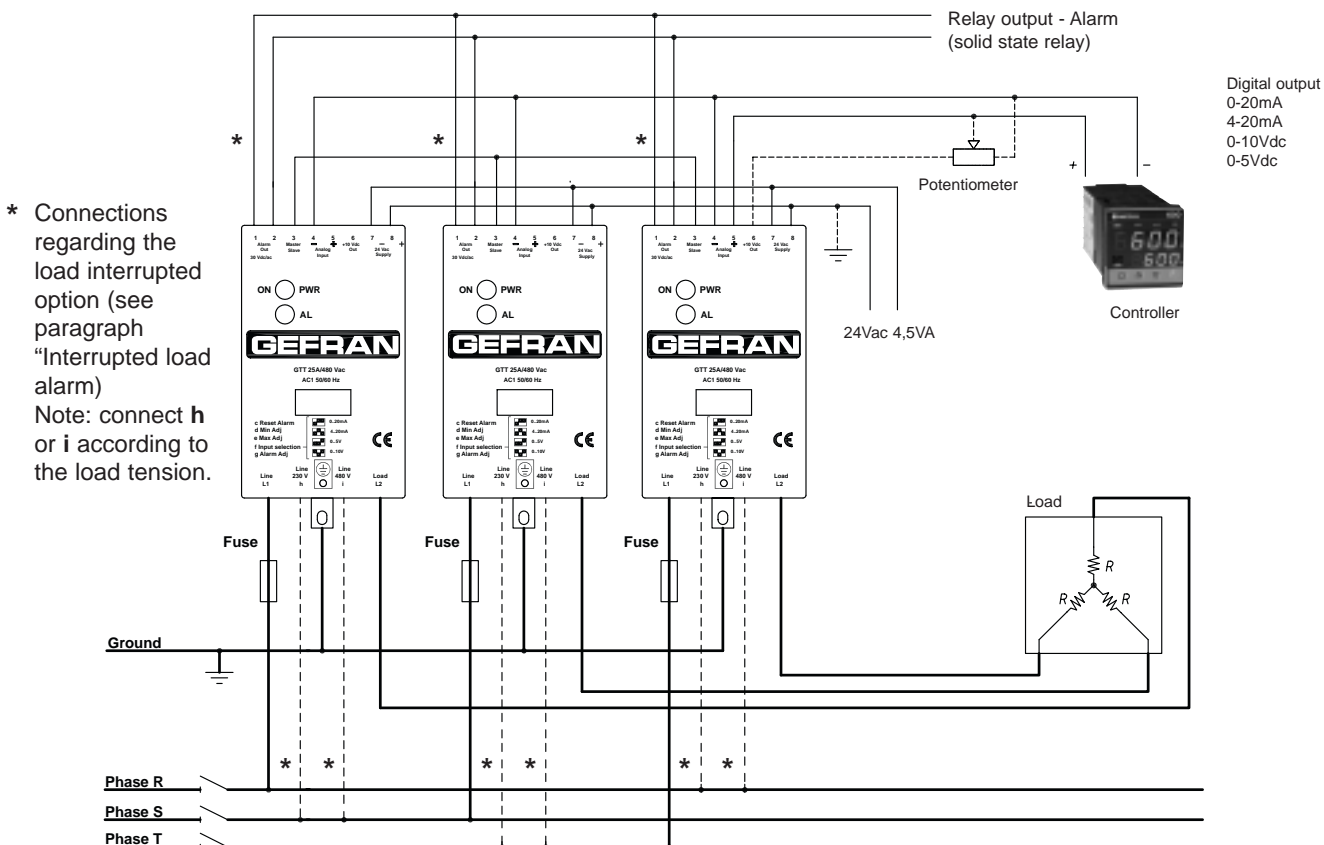

## CONNECTION EXAMPLES

Three-phase connection (triangle or star) without neutral, with control of two phases using one GTT in Master configuration and one GTS in Slave configuration.

\* Connections regarding the load interrupted option (see paragraph "Interrupted load alarm")  
Note: connect **h** or **i** according to the load tension.

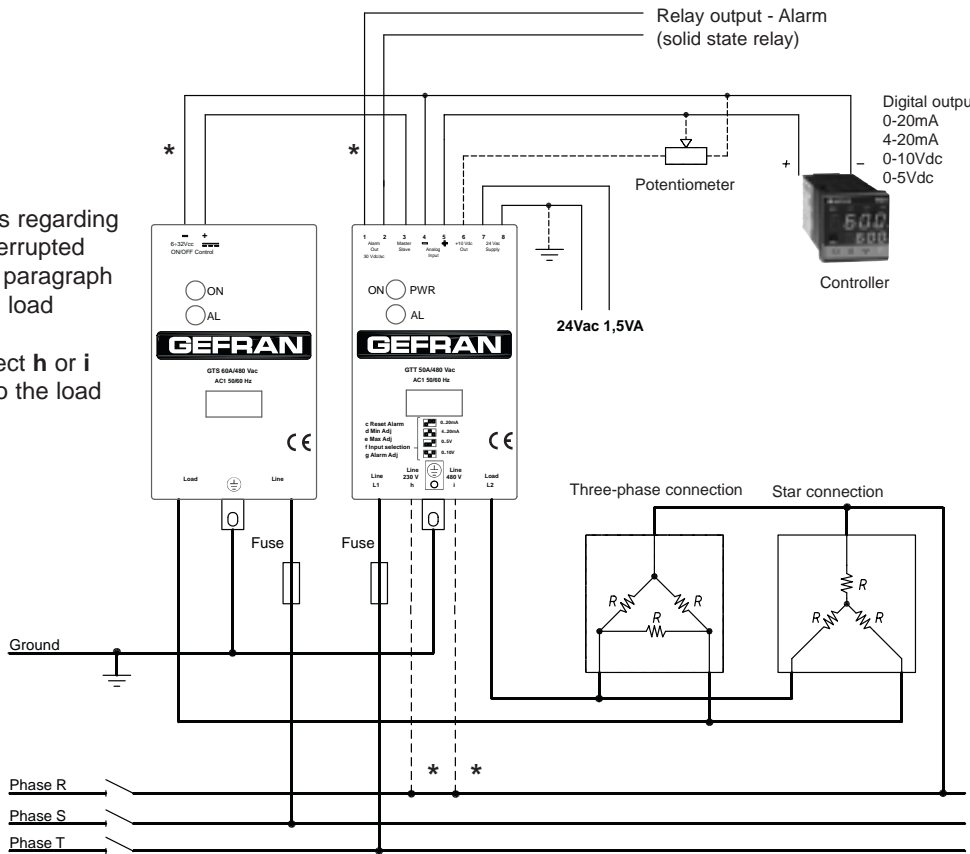

Three-phase star connection with neutral using one GTT in Master configuration and two GTSs in Slave configuration.

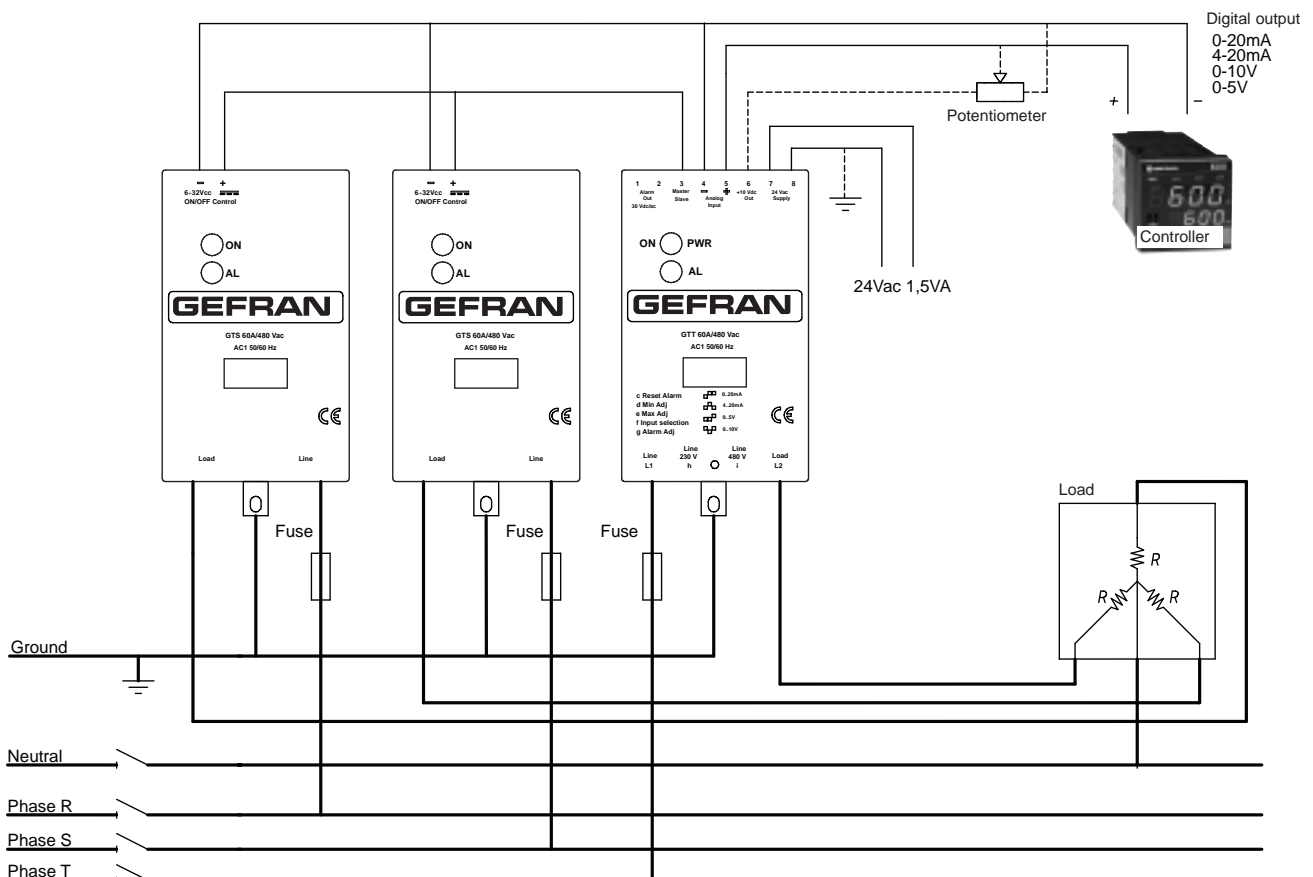

## ACCESSORIES

A wide range of accessories is available (including fuses and fuse holders, supports for fastening DIN bar, ID plates, thermostats, current transformers and isolation transformers). To choose accessories, see the section "Solid state relays - Accessories."

## ORDER CODE

Model		GTT	/	480	-	-	
Nominal current							
25Aac	25						
40Aac	40						
50Aac	50						
60Aac	60						
75Aac	75						
90Aac	90						
120Aac (*)	120						
(*) Specify fan supply: 115Vac or 230Vac							
Nominal voltage							
480Vac	480						
Load interrupt (HB) option							
Without option	0						
With load interrupt option	1						

Fan (for model 120A only)	
Fan 80x80x40 230V 14W	VEN90
Fan 80x80x40 115V 14W	VEN91

Please contact GEFTRAN personnel for information on availability of codes.

## •WARNINGS



**WARNING:** this symbol indicates danger.

**Before installation, please read the following advices:**

- follow the indications of the manual scrupulously when making the connections to the instrument.
- use a cable that is suitable for the ratings of voltage and current indicated in the technical specifications.
- if the instrument is used in applications where there is risk of injury to persons and damage to machines or materials, it is essential that it is used with an auxiliary alarm device.

It is advisable to verify frequently that the alarm device is functional even during the normal operation of the equipment.

- The instrument must NOT be used in environments where there could be the presence of dangerous atmospheres (inflammable or explosive).
- During continuous operation, the heatsink may reach 100°C and remain at a high temperature due to thermal inertia even after the device is switched off. Therefore, DO NOT touch the heat sink or the electrical wires.
- do not operate on the power circuit unless the main supply is disconnected.
- DO NOT open the cover if device is "ON"!

(use the holes in the cover for eventual re-calibration).

**Installation:**

- connect the device to the ground using the proper ground terminal.
- the power supply wiring must be kept separate from that of inputs and outputs of the instrument; always check that the supply voltage corresponds to that indicated on the instrument cover.
- evitare la polvere, l'umidità, i gas corrosivi, le fonti di calore.
- keep away from dust, humidity, corrosive gases and heat sources.
- The connection cable must be shorter than 3 meters if the current transformer is used.

**Maintenance:** Check the correct operation of the cooling fans at regular intervals; clean the ventilation air filters of the installation at regular intervals.

- Repairs must be performed only by specialized or appropriately trained personnel. Cut off power to the device before accessing internal parts.
- Do not clean the box with solvents derived from hydrocarbons (trichloroethylene, gasoline, etc.). Using such solvents will compromise the mechanical reliability of the device. To clean external plastic parts, use a clean cloth wet with ethyl alcohol or water.

**Technical service :** GEFTRAN has a technical service department. Defects caused by use not conforming to the instructions are excluded from the warranty.

GEFRAN spa reserves the right to make any kind of design or functional modification at any moment without prior notice



This device conforms to European Union Directive 2004/108/CE and 2006/95/CE as amended with reference to generic standards: **EN 61000-6-2** (immunity in industrial environment) **EN 61000-6-4** (emission in industrial environment) - **EN 61010-1** (safety regulations).



In Conformity with **UL508 - File: E243386**

# GEFRAN

GEFRAN spa via Sebina, 74 - 25050 Provaglio d'Iseo (BS)  
Tel. 03098881 - fax 0309839063 - Internet: <http://www.gefran.it>

DTS\_GTT\_0709\_ENG