

The MX4 series of Gefran, are pressure transmitters for using in High temperature environment.

The main characteristic of this series is the capability to read temperature of the media up to 400°C.

The constructive principle is based on the hydraulic transmission of the pressure.

The fluid-filled system assures the temperature stability. The physical measure is transformed in a electrical measure by means the strain-gauge technology.

### MAIN FEATURES

- Pressure ranges: 0-25 to 0-2000bar / 0-360 to 0-30000psi
- Extensimetric measurement principle with Wheatstone bridge
- Precision: <  $\pm 0.25\%$  FSO (H); <  $\pm 0.5\%$  FSO (M)
- Calibration signal 80% FSO internally generated
- Completely interchangeable with all existing products
- Protection level: IP65 (6-pin connector)
- Flange Mounting
- Stainless steel diaphragm 15-5 PH with GTP
- For ranges below 100bar-1500psi: 17-7 PH corrugated stainless steel diaphragm with GTP coating
- Other diaphragm types available on request

### TECHNICAL SPECIFICATIONS

Rated precision, including effects of Linearity, Repeatability and Hysteresis	<b>H</b> < $\pm 0.25\%$ FSO (100...2000 bar) <b>M</b> < $\pm 0.5\%$ FSO (25...2000 bar)
Resolution	Infinite
Pressure ranges	0...25 to 0...2000bar 0...360 to 0...30000psi
Maximum applicable pressure	2 x FS 1,5 x FS beyond 1000bar/15000psi
Principle of measurement	Strain gauge
Power supply	12...30Vdc
Maximum input	30mA
Isolation resistance (at 50 Vdc)	> 1000 M $\Omega$
Signal at rated pressure (FSO)	20mA
Zero balancing	4mA
Calibration: Rated pressure Room pressure	5% FSO min. 10bar (150psi)
Maximum load	see diagram (page 3)
Response time (10 at 90% FSO)	~ 4ms
Output noise (RMS 10-400Hz)	< 0.05% FSO
Calibration signal	80% FSO
Protection against overvoltages and power supply polarity reverse	YES
Temperature range of Strain Gauge Housing	-20...+70°C -4...+158°F
Thermal drift in compensated range: Zero/Calibrat/Sensitivity	< 0.02% FSO/°C < 0.01% FSO/°F
Maximum temperature of diaphragm	400°C / 750°F
Influence due to fluid temperature change (zero)	0.02 bar/°C 15 psi/100°F
Standard material in contact with process medium	Diaphragm: • 15-5 PH with GTP coating • 17-7 PH corrugated diaphragm with GTP coating for ranges <100 bar (1500psi) Stem: • 17-4 PH
Sealing	Copper washer silver plated
Protection level (with 6-pin female connector installed)	IP65
Electrical connections	6-pin conn. VPT07RA10-6PT (PT02A-10-6P) 8-pin conn. PC02E-12-8P

FSO = Full Scale Output (Signal at rated pressure)

Power at zener barrier or active barrier. For version MX2, the thermocouple must be connected to EX-i circuits with devices assigned to galvanic separation and with protection mode [EX ia] IIC.

#### Main intrinsic safety characteristics

Transmitter designed and produced in compliance with Directive 94/9/CE ATEX and according to European standards.  
For the second group (II-surfaces), category 1, explosive atmosphere with presence of gases, fumes or mists (G) protection mode Ex ia IIC T5, T4 room temperature -20°C/+55°C/+70°C

Maximum voltage	30 V
Maximum current	100 mA
Maximum power	0,75 W
Equivalent inductance (*)	0,23 mH
Equivalent capacity (*)	26 nF

(\*) includes inductance levels and capacity of a cable: (typical L 1microH/m and typical C 100pF/m) with maximum length 15m.



EC-Type Examination Certificate number:  
**CESI 02 ATEX 107**

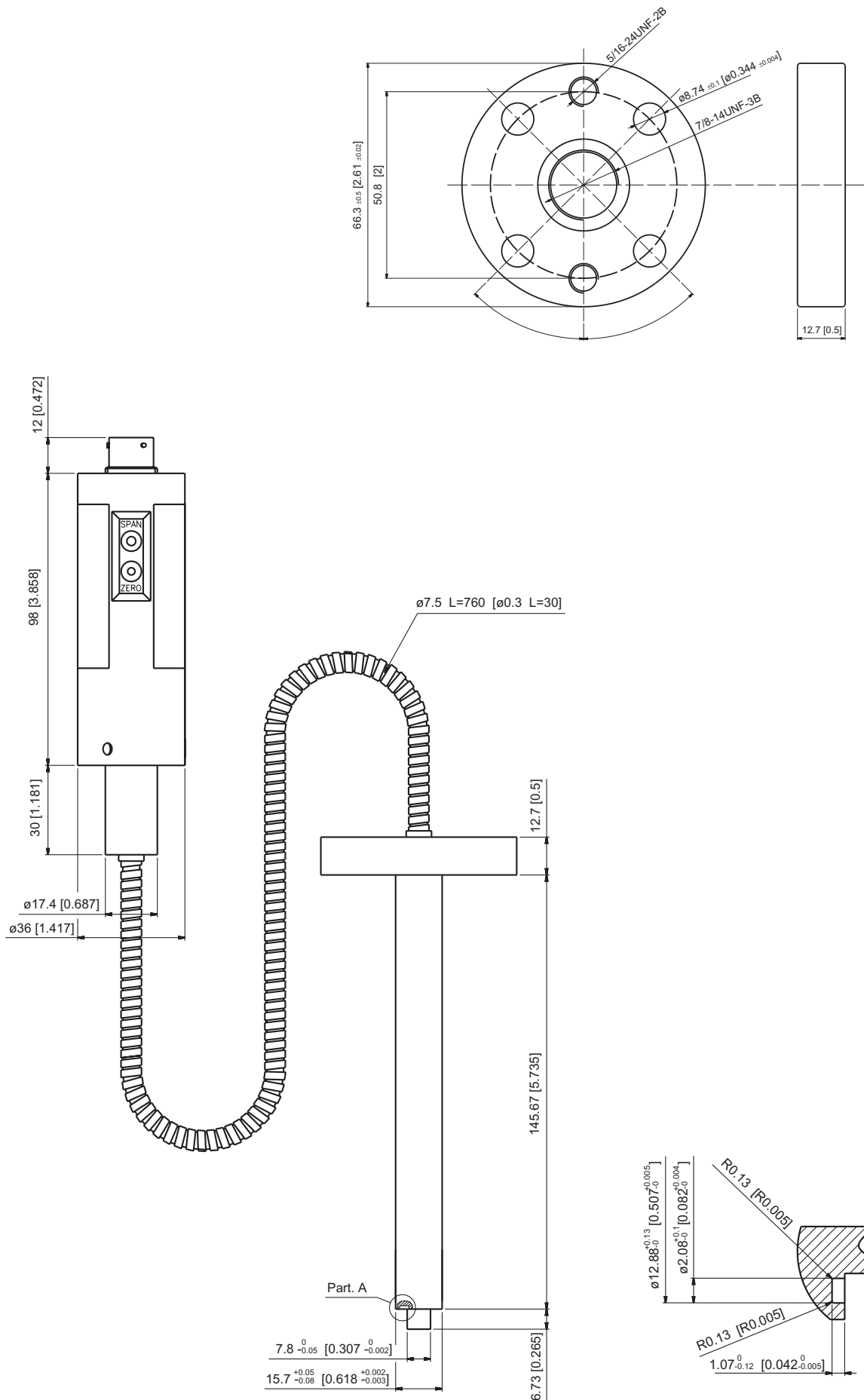

# MECHANICAL DIMENSIONS



## ELECTRICAL CHARACTERISTICS AND TEMPERATURE CLASSES

MODEL	(*) DISTANCE L2	TEMPERATURE CLASSES	ROOM TEMPERATURE
MX4	> 785mm	T5 T4	-20...+55°C -20...+70°C

(\*) with the level (L) in fig. 1, the table sets the minimum distance that the electrical circuit has to maintain from the block at high temperature.

-  thermal isolating material with adequate thickness for the process temperature
-  installation Vs process
-  fluid at temperature Max. (400°C)

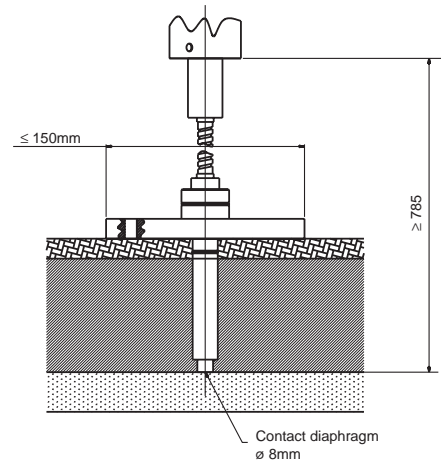

## ELECTRICAL CONNECTIONS

*Output in current (4...20mA 2 wires)*

	6-pin	8-pin
Power supply (12...30Vdc) +	A	B
n.c.	C	A
Signal (4...20mA) -	B	D
n.c.	D	C
Calibration shunt	E - F	E - F
n.c.		G - H

The cable sheathing is connected to the transducer body

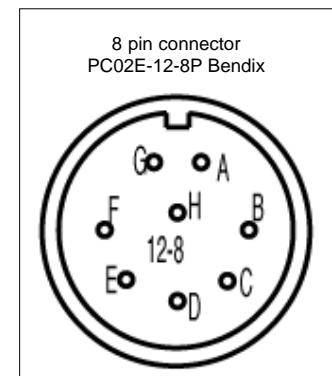
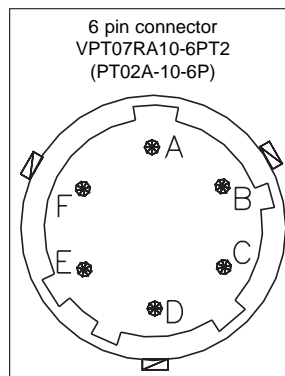

## LOAD DIAGRAM (current output)

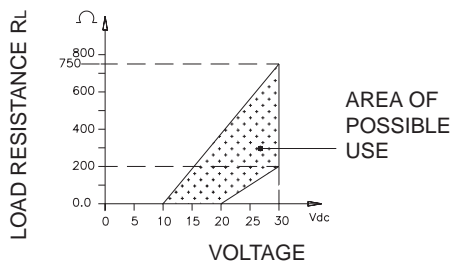

The diagram shows the best ratio of load to power supply for transmitters with 4...20mA output. For correct function, use a combination of load resistance and voltage that stays in the shaded zone.

## SETTINGS

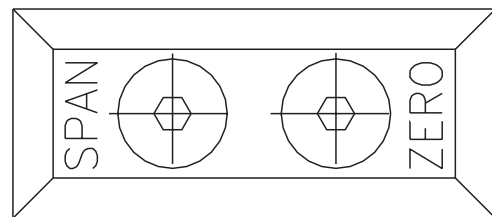

The signal setting to room pressure (ZERO) and the setting to rated pressure (SPAN) can be made with the appropriate trimmers, accessed inside the transmitter after removing the two fastening screws.

**The SPAN setting is made during production and must not be changed.**

### Accessories

Mounting bracket  
Copper washer silver plated

### Extension cables

<b>SF18</b>	6-pin connector with 3mt Atex cable	<b>PCAV221</b>
<b>RON007</b>	6-pin connector with 4mt Atex cable	<b>PCAV104</b>
	6-pin connector with 5mt Atex cable	<b>PCAV105</b>
	6-pin connector with 10mt Atex cable	<b>PCAV106</b>

## ORDER CODE

M - 000

000= Special executions of the standard version or of custom versions may be requested.

OUTPUT SIGNAL	
4...20mA	X

4	T4
5	T5

CONFIGURATION	
Flange mounting	4

FLEXIBLE ROD LENGTH		
F	760mm	30"

CONNECTOR		
Standard		
6 pin	6	
8 pin	8	

RIGID ROD LENGTH (mm / inches)		
Standard		
4	153mm	6"
Available on request		
H	102mm	4"
M	229mm	9"
5	305mm	12"

PRECISION CLASS		
0.25% FSO (ranges ≥100 bar/1500 psi)	H	
0.5% FSO	M	

FLANGE MOUNTING	
Standard	
6	∅ 66.3mm (2.61")

MEASUREMENT RANGE			
bar		psi	
25	B25U	360	P36D
35	B35U	500	P05C
50	B05D	750	P75D
70	B07D	1000	P01M
100	B01C	1500	P15C
200	B02C	3000	P03M
350	B35D	5000	P05M
500	B05C	7500	P75C
700	B07C	10000	P10M
1000	B01M	15000	P15M
1400	B14C	20000	P20M
2000	B02M	30000	P30M

### Example

#### **MX4-6-M-B07C-6-4-F-4-000**

Melt pressure transducer with flange mounting, 4...20mA output, 6-pin connector, pressure range 700bar, precision class 0.5%, 153mm (6") rigid rod, 760mm (30") flexible rod, temperature class T4.

Sensors are manufactured in compliance with:

- EMC 2004/108/CE compatibility directive
- RoHS 2002/95/CE directive
- ATEX 94/9/CE

Electrical installation requirements and Conformity certificate are available on our web site: [www.gefran.com](http://www.gefran.com)



The Melt pressure transmitter/transducer are available with GOST-R certification. The request of this version must be specified on the order.

GEFRAN spa reserves the right to make aesthetic or functional changes at any time and without notice.